

# safety connects.

Your direct connection to maximum safety in  
daily solvent handling.

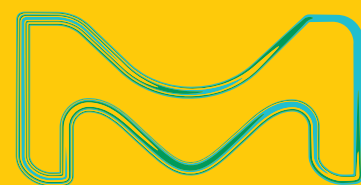

The life science business of Merck  
KGaA, Darmstadt, Germany  
operates as MilliporeSigma in the  
U.S. and Canada.

**Supelco**®  
Analytical Products

# Solvent management systems

We invest heavily in safe and innovative solvent handling technology and product development, focusing on customer requirements and offering a wide range of products and accessories. Our primary goal is to ensure user safety and the reliability of analytical results in your laboratory.

For many years, we have worked closely with customers to develop solvent withdrawal systems that are tailor-made according to solvent grades and packaging types.

Today, our broad range of withdrawal systems and containers is unrivaled in the industry. As a result, customers are assured that, whatever the application is, we can supply an integrated solution with the right solvent grade in the right container and with the right withdrawal system for highest safety and optimal results.



# Table of Contents

	pages
All you need for your individual application	04 – 05
Pack size recommendation	06 – 07
Safety and protective features	08 – 09
Service & Support	10 – 11

## Packaging properties, Withdrawal systems & Installation options

Bottles	12 – 19
Drums	24 – 35
Barrels	36 – 45
Containers	46 – 47

## Safety Accessories

Safety accessories for bottles	20 – 23
Safety accessories for barrels & drums	48 – 49
Level sensors	50 – 51

**Customized installations** 52 – 53

**Ordering information & product pictures** 54 – 59

## Useful technical tables

Withdrawal system suitability	60 – 61
Connections for barrels & drums	60 – 61
Tubings	62
Bottle connections	63

# All you need for your individual application



**Glass bottles**  
0.5 L - 4 L

Page 14



**Aluminum bottle**  
5 L

Page 18



**Stainless steel barrels**  
10 L - 185 L



Pages 36-39



**Other barrels and containers**  
≥ 1,000 L



Page 46



**Glass bottles**  
0.5 L - 4 L

Page 14



**Stainless steel barrels**  
10 L - 185 L



Pages 36-39



## Instrumental analysis

**Uvasol®**..... Spectroscopy

**SupraSolv®**  
**UniSolv™** ..... Gas chromatography

**MagniSolv®** ..... NMR spectroscopy

**LiChrosolv®** ..... HPLC

## Preparation & Purification

**Solvents for DNA & peptide synthesis**

**Prepsolv®**..... Solvents for preparative chromatography

► Pack size recommendation and return system  
Turn the page for more detailed information on packaging sizes.

## Classical analysis and synthesis

**EMSURE®** ..... Solvents for analysis  
ACS, ISO, Reag. Ph Eur

**EMPARTA®** ..... Solvents for analysis ACS

**EMPLURA®** ..... Solvents for lab applications



**Glass bottles**  
0.5 L – 4 L

Page 14



**HDPE bottles**  
1 L – 5 L

Page 16



**Aluminum bottles**  
5 L

Page 18



**Stainless steel drums**  
10 L – 190 L

RETURNABLE PACKAGING 

Pages 24-27



ONE-WAY PACKAGING

**Other drums and containers**  
10 L – ≥1,000 L

Page 32

**Other barrels and containers**  
≥ 1,000 L

Page 46



RETURNABLE PACKAGING 

**Fully sealed stainless steel barrels**  
10 L – 30 L

Page 39



RETURNABLE PACKAGING 

**Stainless steel drums**  
10 L – 190 L

Pages 24-27

# Pack size recommendation and return system

We have a strong track record in developing practical and safe packaging concepts and chemical packaging that preserve the high quality of our solvents. We have been authorized as an official inspection authority by the Federal Institute for Material Research and Testing of Germany (BAM).

Our unique variety of packaging sizes and types for organic solvents provides a solution for each of your individual applications.

## Pack size recommendation

Bottles



Metal drums



Stainless steel drums & barrels



Pack sizes

0.5 L – 5 L

10 L – 190 L

Annual consumption

0.5 L – 100 L

100 L – 1,000 L

Standard packaging

Standard packaging range **one-way packaging**

Stainless steel drums **optionally returnable packaging**

Stainless steel barrels **mandatorily returnable packaging**

- Advantage: no rinsing / cleaning / disposing
- Return unrinsed with original labels and tightly closed

## Intermediate bulk containers (IBC) Tank trucks



190 L – 20,000 L

> 1,000 L

### Stainless steel containers **mandatorily returnable packaging**

- Customized products and containers
- Individual processes with rental agreements

## Return system

Stainless steel barrels and drums are part of a return process. The reuse of barrels and drums makes it possible to conform to packaging regulations that require packaging waste to be reduced or even avoided. In this way, supplier and user act together in a partnership in reducing packaging waste.

### Return system chart

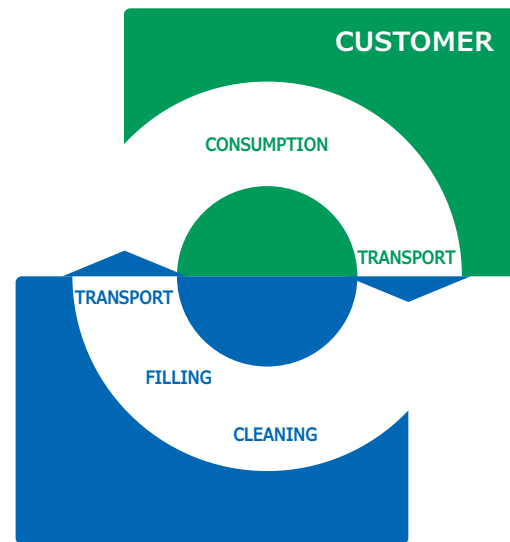

Stainless steel barrels and containers are mandatory to be returned and are coded with a unique ID number – **mandatorily returnable packaging**.



Stainless steel barrels and containers are mandatory to be returned and are coded with a unique ID number – **optionally returnable packaging**.



Metal drums are used as **one-way packaging**.



# Safety and protective features

Packaging must meet or exceed minimum performance standards given by the specifications of the United Nations before it can be authorized for the carriage of dangerous goods. If they pass the test, the packaging becomes a design-type, certified by a national competent authority. Coded with a unique marking it is easy for our customers to read important safety advantages directly.

## UN 1A1/X2.3/900/99/D/BAM8361-TCS

- UN** United Nations Packaging Symbol
- 1** Drum
- A** Steel
- 1** Non-removable head
- X** For packaging groups I, II and III
- 2.3** With a relative density of 2.3 and a vapor pressure of max. 230 kPa
- 900** Hydrostatic test pressure in kPa (900 kPa = 9 bar)
- 99** Year of manufacture = 1999
- D** Origin of manufacture = Deutschland (Germany)
- BAM8361** Approval authority with unique registration number (= 10 L barrel of Merck KGaA, Darmstadt, Germany)
- TCS** Manufacturer code

Specially shaped barrel top section for safe stacking and usage



Flexible withdrawal system with inert gas pressurizing for stainless steel barrels and drums



Engraved identification number for complete monitoring of the barrel (e.g. automatic stop for safety test, tracing)



UN approved packaging for safe transport of dangerous goods



Specially developed screw-cap for tight closure without leakage and contamination



Variety of bottles in different materials and sizes for your individual demand



### Fire triangle and static electricity

If flammable liquids (e.g. solvents) are to be used, the container (10 L and more) must be properly earthed according to valid safety regulations to avoid explosion and fire risks. Appropriate measures must be taken to discharge static electricity. General warnings and safety instructions must be observed, they reduce the risk of electrostatic separation of charges to increase safety in daily solvent handling dramatically.

#### Oxidizer

Planned introduction of air, inadvertent introduction of oxygen, release of hydrocarbons into air, weathered fluids, oxidizers

#### Ignition source

Heat, electricity, static electricity, friction, chemical reactions, spontaneous combustion, dieseling, pyrophors, sudden decompression, catalytic reactions

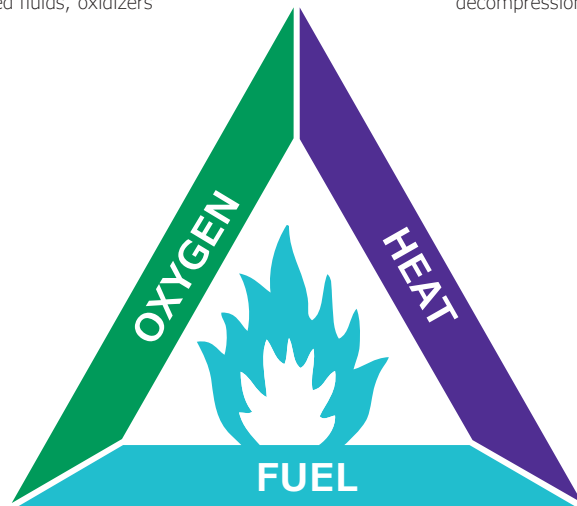

Heavy and light gases, hydrocarbon liquids and vapors, vapors of chemicals / lubricants / solvents, frac oils, flammable materials

Design improved drum top with engraved UN code for safe stacking and usage



Manual withdrawal system for safe flexibility for all barrels and drums of 10, 25 and 30 L volume



Specially shaped bottom section of drums and barrels for optimal emptying of residues

## Safe handling with our protective features

- ▶ Earthing with an antistatic device  
For further information please have a look at page 48.
- ▶ Using a fume hood  
More details on page 42.

# Service and support

MilliporeSigma creates sustainable value and provides a wide range of customized services to meet your individual requirements.

We have extensive experience in handling all types of hazardous materials, including highly sensitive substances in specially developed packaging with directly connectable, safe withdrawal systems.

Please make use of our various information platforms as well as of our customized service and support for your individual lab environment and application.



## Our websites

Please visit our solvents websites:

**[EMDMillipore.com/solvents](https://www.emdmillipore.com/solvents)**

**[SigmaAldrich.com/classical-lab-chemicals](https://www.sigmaaldrich.com/classical-lab-chemicals)**

for additional product information.





### Technical details

Our withdrawal systems include comprehensive manuals with safety and handling instructions. Additionally all installation steps are described with many pictures to provide maximum safety in daily solvent handling.

Please contact your local MilliporeSigma agent for additional information on the ordered products.



### Online Media

Please visit our special withdrawal system websites for additional product information on withdrawal systems, handling videos and important safety topics in daily solvent handling.

Withdrawal systems:  
**EMDMillipore.com/solvents-withdrawal**  
 Safety film & handling video manuals:  
**EMDMillipore.com/safety-film**



### Technical drawings

Please contact your local MilliporeSigma agent for technical drawings of your individual installation or on products of interest.

### Print Media

Information on solvents and accessories can also be found in our solvents catalogue. "Accuracy you can count on" (order no. W282105). Please ask your local MilliporeSigma supplier for a printed copy or visit us at

**EMDMillipore.com/solvents-literature**  
 for pdf download.



### Safety, regulations & requirements

Please visit our website **EMDMillipore.com/safety** for questions concerning your lab safety, e.g. basic lab rules, safety data sheets or safe storage.



# Bottles – a large variety for every need

MilliporeSigma's demanding quality standards apply not only to the reagents themselves but also to the packaging they are supplied in; each material being carefully developed and matched to its product specification. Our extensive variety of packaging types and sizes is unrivaled in the industry. Each of your individual demands can be covered with bottle pack sizes from 0.5 L to 5 L and materials from glass with and without septum lids to HDPE and aluminum.



## Glass bottles | pages 14 – 15

- Safe and convenient handling, storage and transportation – use our available safety accessories
- S40 thread with special shape for safe pouring
- S40 screw cap with tamperproof seal
- High pressure resistance
- Premium amber blank glass suitable even for aggressive chemicals
- Pulp packaging (molded fiber trays) for safe transportation of glass bottles



### HDPE bottles | page 16

- Made from high-density polyethylene (HDPE)
- No risk of fracture – cost reduction by avoiding additional packaging material
- Safe and convenient handling by large integrated handle or available pouring aid (for 1L)
- Low tare weight facilitates handling and reduces transport costs
- S40 thread with special shape for safe pouring
- S40 screw cap with tamperproof seal
- High pressure resistance



### Withdrawal systems

Take advantage of perfectly matched systems for maximum safety in your individual application.

- ▶ Manual withdrawal system | pages 23-24



### Aluminum bottle | page 18

- No risk of fracture – cost reduction by avoiding additional packaging material
- Safe and convenient handling by integrated pouring ring
- Low tare weight facilitates handling and reduces transport costs
- S40 thread with special shape for safe pouring
- S40 screw cap with tamperproof seal
- High pressure resistance

### All about ...

## Safety accessories for bottles

| pages 20-23

Handling hazardous goods daily demands highest health protection. Specially for solvents in glass bottles there are several additional safety products available that increase your laboratory safety dramatically.

# Amber Glass bottles

[available from 0.5 L up to 4 L]



- + **Withdrawal system** for bottles | pages 22-23
- + **HPLC adapter** to connect bottles directly to HPLC instruments | page 21
- + **Adapter** to connect equipment with different thread sizes (e.g. GL45, S38) | page 63
- + **Level sensors** to connect bottles directly to HPLC instruments and monitor / manage bottles in process-related steps automatically | page 46

**Specially developed S40 thread**  
withstands higher contact pressure  
and ensures tighter seals

**Specially formed,  
sharp thread lip**  
for safe drip free pouring

**Specially treated  
high quality glass**  
with extreme durability due to  
constant wall thickness for highest  
safety and product quality

**Pour ring for safe and  
ergonomic withdraw**  
tension-free  
manufacturing technology:  
"bottle out of one drop" to  
avoid any predetermined  
breaking point

**New S40 screw cap**  
Tamper proof closure will remain  
as ring on the bottle neck

**Long shelf life of contents**  
due to bottle's impermeability  
to air and water vapor as well  
as protection against light

**Unique, clear and  
complete labeling**  
with product specifications  
and all relevant hazard  
declarations

**Broad and stable base**  
for safe stand with low point  
of gravity



## Technical data

### Material:

Moulded amber glass, hydrolytic class 3

### Available packaging size:

0.5 L, 1 L, 2.5 L and 4 L

### Height, diameter and net weight (bottle size):

180 mm, ø 83 mm, approx. 450 g (0.5 L)













222 mm, ø 101 mm, approx. 600 g (1 L)

258 mm, ø 151 mm, approx. 1,140 g (2.5 L)

350 mm, ø 162 mm, approx. 1,525 g (4 L)



## Safety accessories for Amber Glass Bottles | pages 20-23

Products	Ord. No.
<b>Safe handling</b>	
 Safety carrier for 1L / 2.5l glass bottles	<b>9.20078.0001</b>
 Safety carrier for 4L glass bottles	<b>1.40140.0001</b>
 Pouring aid for 1L / 2.5 glass bottles	<b>1.02547.0005</b>
 Bottle opening key S40 / S28	<b>1.08801.0001</b>
 Label set for self-labelling mixtures	<b>1.00801.0001</b>
<b>Withdrawal systems for solvents in glass bottles</b>	
 Withdrawal system for bottles with manual pressure build-up	<b>1.78178.0001</b>
<b>Adapters for direct connection of solvent bottles to HPLC-instruments</b>	
 HPLC-bottle adapter S40 (supply)	<b>1.03830.0001</b>
 HPLC-bottle adapter S40 (disposal)	<b>1.03831.0001</b>
 Exhaust air filter for HPLC-bottle adapter S40 (disposal)	<b>1.03833.0001</b>
<b>Adapters for direct connection of solvent bottles to HPLC-instruments WITH LEVEL SENSOR technology</b>	
 Adapter with integrated level sensor (supply)	<b>9.67100.2001</b>
 Adapter with integrated level sensor (disposal)	<b>9.67100.2002</b>
 Display and alarm device for bottle level sensor	<b>9.67100.2004</b>

# HDPE bottles

[available from 1 L up to 5 L]



- + **Withdrawal system** for bottles | pages 22-23
- + **Adapter** to connect equipment with different thread sizes (e.g. GL45, S38) | page 63

**Specially developed S40 thread** withstands higher contact pressure and ensures tighter seal

**Specially formed sharp thread lip** for safe drip free pouring

**Specially treated high quality HDPE** with extreme durability, inertness and shock resistance for highest safety and product quality

**Reduced packaging waste (no additional protection material necessary inside card boxes)** to protect the environment and to benefit from economical advantages



**New S40 screw cap**  
Tamper proof closure will remain as ring on the bottle neck

**Integrated handle** for best pouring properties

**Unique, clear and complete labeling** with product specifications and all relevant hazard declarations

**Low bottle weight** for easy, safe and economic solvent handling

**Special base geometry** of 2.5L bottles prevents bulging

## Technical data

### Material:

HDPE (High-density polyethylene)

### Available packaging size:

1 L, 2.5 L and 5 L

### Height, diameter and net weight (bottle size):





206 mm,  $\varnothing$  101 mm, approx. 66 g (1 L)

322 mm,  $\varnothing$  125 mm, approx. 145 g (2.5 L)

330 mm,  $\varnothing$  178 mm, approx. 335 g (5 L)



## Safety accessories for HDPE Bottles | pages 20-23

Products	Ord. No.
<b>Safe handling</b>	
 Bottle opening key S40 / S28	<b>1.08801.0001</b>
 Label set for self-labelling mixtures acc. to GHS, DIN EN ISO & GLP	<b>1.00801.0001</b>
 Safety stand for 2.5L HDPE bottles	<b>9.67213.0001</b>
<b>Withdrawal systems for solvents in HDPE bottles</b>	
 Withdrawal system for bottles with manual pressure build-up	<b>1.78178.0001</b>

# Aluminum bottle

[available for 5 L]



- + **Withdrawal system** for bottles | pages 22-23
- + **Adapter** to connect equipment with different thread sizes (e.g. GL45, S38) | page 63



## Technical data









**Material:** Aluminum

**Available packaging size:** 5 L

**Height, diameter and net weight:**

298 mm,  $\varnothing$  175 mm, approx. 285 g

## Safety accessories for Aluminum Bottles | pages 20-23

Products	Ord. No.
<b>Safe handling</b>	
 Bottle opening key S40 / S28	<b>1.08801.0001</b>
 Label set for self-labelling mixtures acc. to GHS, DIN EN ISO & GLP	<b>1.00801.0001</b>
<b>Withdrawal systems for solvents in aluminum bottles</b>	
 Withdrawal system for bottles with manual pressure build-up	<b>1.78178.0001</b>
<b>Adapters for direct connection of solvent bottles to HPLC-instruments</b>	
 HPLC-bottle adapter S40 (supply)	<b>1.03830.0001</b>
 HPLC-bottle adapter S40 (disposal)	<b>1.03831.0001</b>
 Exhaust air filter for HPLC-bottle adapter S40 (disposal)	<b>1.03833.0001</b>
<b>Adapters for direct connection of solvent bottles to HPLC-instruments WITH LEVEL SENSOR technology</b>	
 Adapter with integrated level sensor (supply)	<b>9.67100.2001</b>
 Adapter with integrated level sensor (disposal)	<b>9.67100.2002</b>
 Display and alarm device for bottle level sensor	<b>9.67100.2004</b>

# Safety accessories for bottles

Handling hazardous goods daily demands highest health protection. Specially for solvents in glass bottles there are several additional safety products available that increase your laboratory safety dramatically.



## Safety carrier

for glass bottles up to 2.5 L [9.20078.0001]  
and up to 4 L [1.40140.0001]

- Safe transportation of glass bottles acc. to guidelines
- Optimal bottle protection due to very effective PE foam inlay
- Additional time for disposal in case of glass breakage inside due to chemical resistant materials
- Leak-proof top cover prevents unintended exposure to liquids and vapors
- Stable, broad handle for convenient handling

## Bottle key

[1.08801.0001]

- Convenient opening and closing of bottles with S40 and S28 screw caps
- Perfectly adapted to the shape of our screw caps
- Maximum safety when working with hazardous liquids



## Safety stand

for 2.5L-HDPE-bottles [9.67213.0001]

- Additional safety e.g. when using the withdrawal system 1.78178.0001 with 2.5 L HDPE bottles
- Prevents overturning of the 2.5 L HDPE bottle





## Pouring aid

for 1L and 2.5L MilliporeSigma bottles with S40 thread (pack of 5) [1.02547.0005]

- Easy, safe and convenient pouring for S40-threaded bottles without integrated handle
- Suitable for all liquids like acids, bases and solvents
- Clipped directly on the bottle neck
- Only for single use – do be disposed of with the bottle: Maximum safety – avoid potential risk of breakage! (Some liquids have a decomposing effect on the pouring aid material.)

## Label set

acc. to GHS, DIN EN ISO and GLP [1.00801.0001]

- Comprehensive label compliant with GHS, DIN EN ISO and GLP standards
- Complete safety information at a glance with adhesive pictograms and signal words
- Non-permanent adhesive for easy, residue-free removal
- Robust plastic label, resistant to chemicals



## HPLC adapter

for direct instrument connection [1.03830.0001 (supply) and 1.03831.0001 + 1.03833.0001 (disposal)]

- Direct instrument adapter for S40-threaded bottles
- No harmful evaporations
- Contamination-free solvent handling
- Stable eluent mixture ratio without contamination
- Easy exchange of bottles
- Multiple connection possibilities



## Adapter with integrated level sensor

for MilliporeSigma bottles with S40 thread for solvent supply [9.67100.2001] and for solvent disposal [9.67100.2002]

- Suitable for solvents (!) in all S40 bottles
- The level sensor is pre-assembled in an S40 screw cap with additional 3 openings for 3 mm HPLC-tubes and blind plugs
- Equipped with a clamping screw, the sensor can be adjusted to several bottle sizes or also to the desired solvent level.
- Optical and acoustic signals in connection to an alarm display. [9.67100.2004]

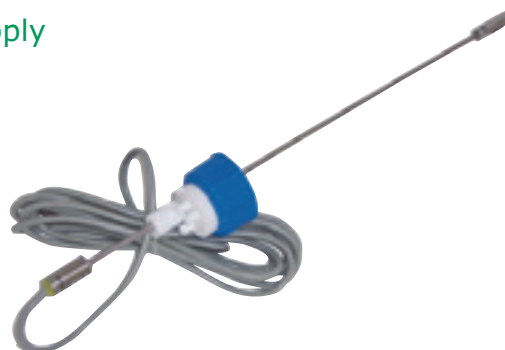

## Safety accessories for bottles

# Withdrawal system with manual pressure build-up for solvents in bottles

**Suitability:** All MilliporeSigma-bottles up to 5 L volume



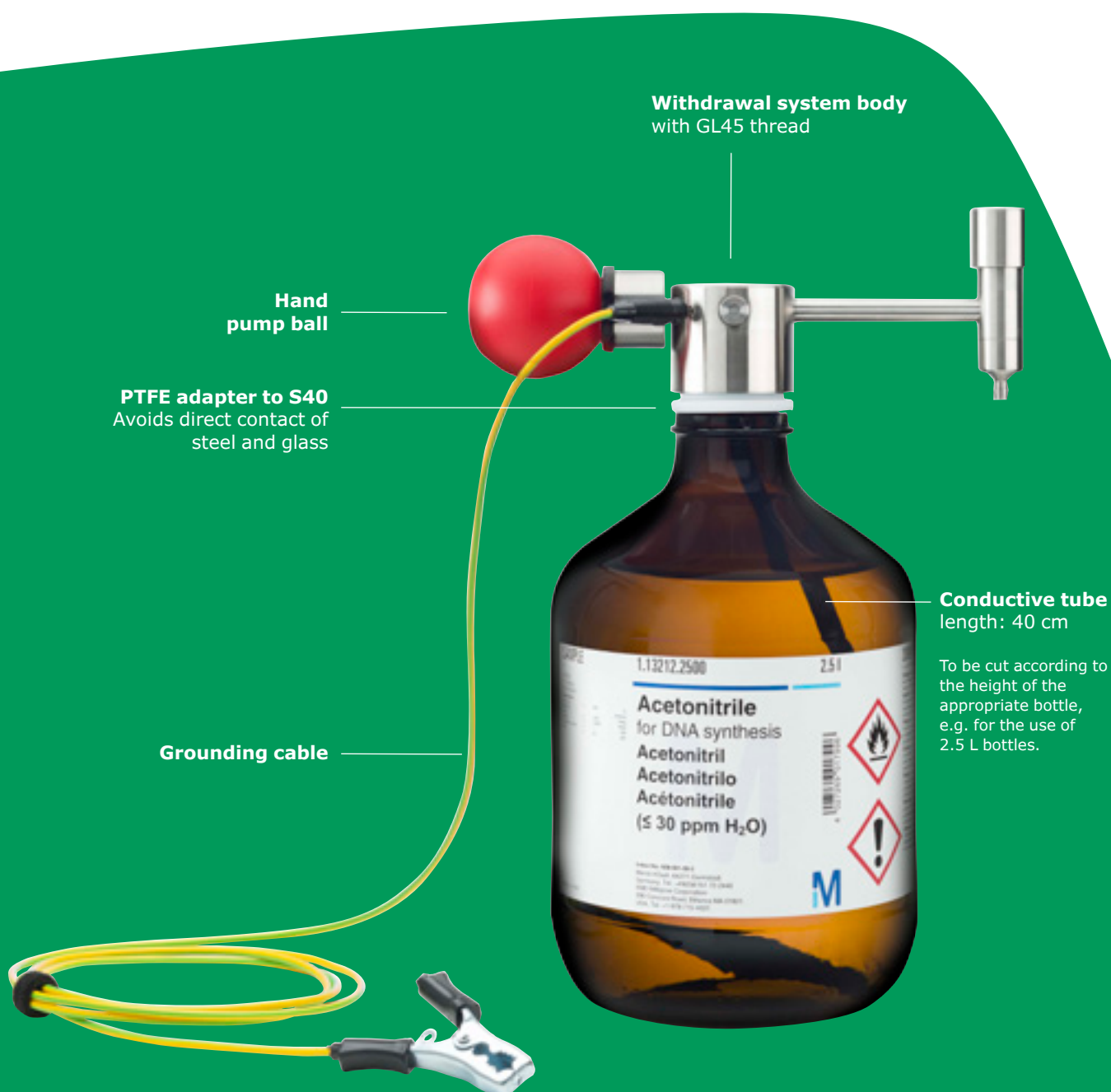

**Operation mode:** Manual pressure build-up by hand pump ball



## Your benefits

- **Safe, easy and contamination-free** solvents withdrawal out of S40 threaded bottles
- **Safety** - safe bottle position and convenient withdrawal of solvents by avoiding pouring
- **Flexibility** - suitable for all MilliporeSigma-bottles made of glass, HDPE and aluminum up to 5 liters

### Accessories | pages 20-22

Products	Ord. No.
<b>Safe handling</b>	
 Safety carrier for 1L / 2.5 L glass bottles	<b>9.20078.0001</b>
 Safety carrier for 4L glass bottles	<b>1.40140.0001</b>
 Bottle opening key S40 / S28	<b>1.08801.0001</b>
 Label set for self-labelling mixtures	<b>1.00801.0001</b>
<b>Spare parts</b>	
 Conductive tubing (5 units, length: 40 cm)	<b>1.78179.0001</b>

# Drums at a glance

As the global market leader in laboratory reagents, we apply our demanding quality and safety standards not only to our reagents themselves, but also to the containers we supply them in. That's why we continuously develop and improve packaging and tailor-made solvent withdrawal systems that meet the requirements of our customers. Today we are able to provide a broad range of withdrawal systems and containers that is unrivaled by any other manufacturer.

Solvent management solutions from MilliporeSigma help to improve your materials management, to minimize the environmental impact of packaging waste and health risks for your employees, and to implement more cost-effective disposal processes.



## Your benefits

- Maximum user safety
- Easy and contamination-free solvent handling
- Application orientated solutions and individual installations
- Ecological and economical benefits

RETURNABLE  
PACKAGING 

10 L



25 L



190 L

**Stainless steel drums | page 26**

- Optimum material characteristics (avoidance of interactions between solvents and packaging material)
- Use as returnable drums
- Can be combined with a variety of withdrawal systems and level sensors
- Optimum emptying
- Stackable

**Withdrawal systems**

Take advantage of perfectly matched systems for maximum safety in your individual application.

- ▶ Manual withdrawal system | page 28
- ▶ Withdrawal system with inert gas pressurizing | page 29
- ▶ Direct instrument connections | page 31

ONE-WAY  
PACKAGING

10 L



25 L



180 / 190 L

**Metal drums | page 32**

In addition to conventional packaging we also implement specific solutions especially for production use. This range includes steel drums from 10 to 180 / 190 liters, depending on the solvent, with a PE-inliner.

**Withdrawal systems**

Take advantage of perfectly matched systems for maximum safety in your individual application.

- ▶ Manual withdrawal system | pages 30 & 35



# Stainless steel returnable drums

[available from 10 L up to 190 L]



- + **Withdrawal system** for manual pressure build-up | pages 28 & 30
- + **Withdrawal system** for pressurizing with inert gas | page 29



## Technical data

Parameter	10 L	25 L	190 L
Height	35 cm	52 cm	88 cm
Diameter	24 cm	29 cm	59.5 cm
Volume	13 L	28 L	215 L
Filling quantity	10 L	25 L	190 L
Weight (empty)	1.9 kg	3.8 kg	18 kg
Number per pallet	15	11	2
Openings	2" centrally and 3/4" decentrally located		
Material	stainless steel 1.4301		



## Safety accessories for Stainless Steel Drums | pages 48-51

Products	Ord. No.
<b>Safe handling</b>	
 Bottle opening key S40 / S28	<b>1.08801.0001</b>
 Label set for self-labelling mixtures	<b>1.00801.0001</b>
 Antistatic set (3 cables)	<b>1.07070.0001</b>
 Stainless steel clamp for filling nozzle, wall attachment	<b>9.67107.0001</b>
 Stainless steel clamp for filling nozzle, attachment to drums	<b>9.67106.0001</b>
 Reducing valve, 0.2 bar with integrated overpressure relief	<b>9.67100.9100</b>
 Pressure safety device, 0.5 bar	<b>9.67100.9004</b>
<b>Withdrawal systems for solvents in drums</b>	
 Withdrawal system with manual pressure build-up	<b>1.01114.0001</b>
 Withdrawal system for inert gas pressurizing	<b>1.06710.0001</b> (additional dip tube necessary)
<b>Dip tubes for inert gas withdrawal system 1.06710.0001</b>	
 Dip tube for 10 l stainless steel drums	<b>9.67100.1010</b>
 Dip tube for 25 l stainless steel drums	<b>9.67100.1025</b>
 Dip tube for 190 l stainless steel drums	<b>9.67100.1190</b>

# Withdrawal systems for stainless steel returnable drums



## Manual pressure build-up by pump ball

- Tested high performance materials to avoid any contamination caused by the system components
- Safe, easy and convenient solvent handling
- High flexibility due to no dependence on gas supply
- Cost effective solution due to economic concept of returnable containers

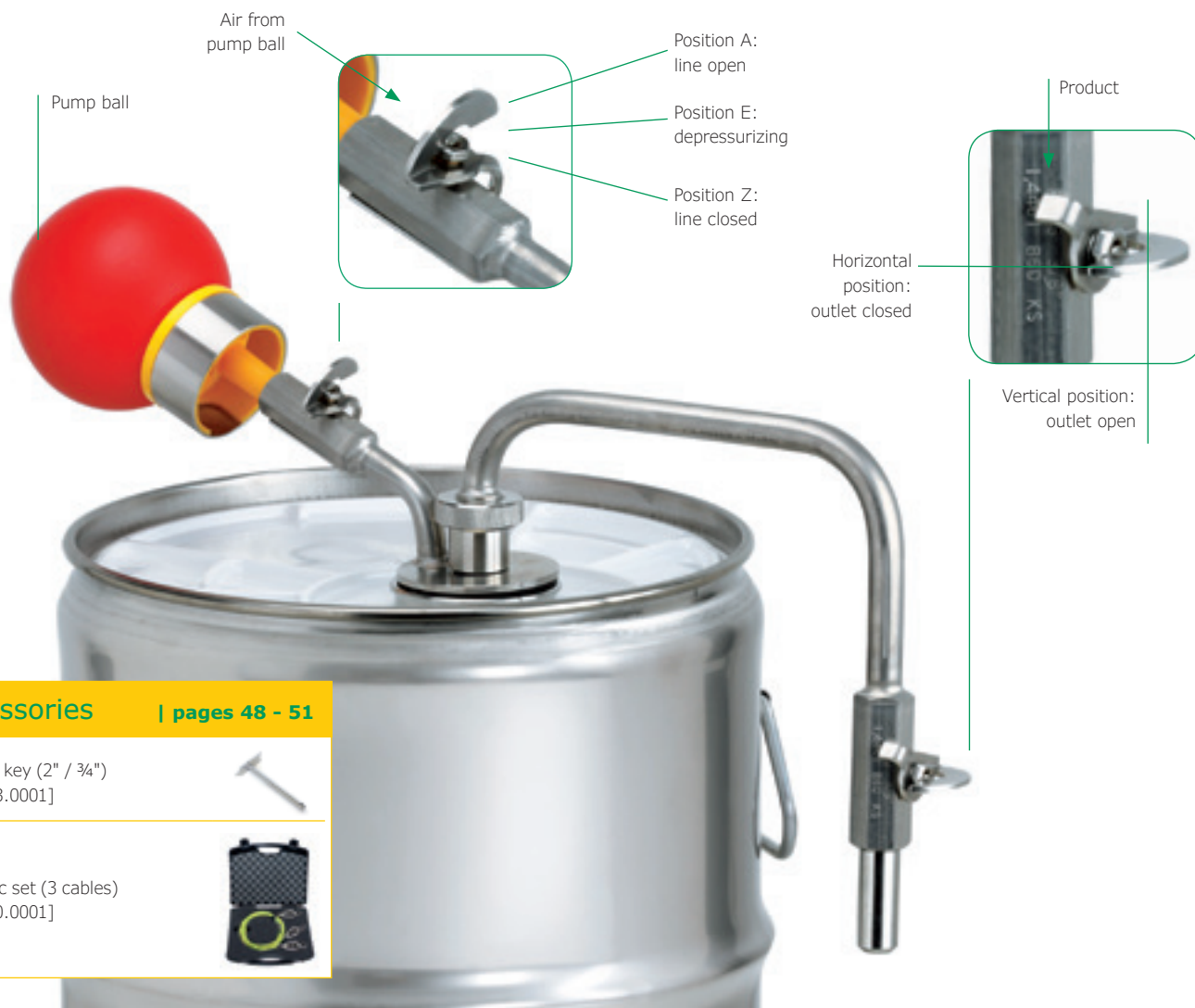

### Accessories | pages 48 - 51

Opening key (2" / ¾")  
[1.08803.0001]



Antistatic set (3 cables)  
[1.07070.0001]



### Spare parts

Dip tube for 10 L drums  
[9.67100.1012]



Dip tube for 25 L drums  
[9.67100.1028]



Hand pump ball  
[9.67114.0000]



### System at a glance

<b>Order number</b>	<b>1.01114.0001</b>
<b>Suitability</b>	10 L and 25 L metal and stainless steel drums
<b>Operation mode</b>	Manual pressure build-up by pump ball
<b>Set components</b>	Withdrawal system body with 2" clamp, 2 shut-off valves (discharge and ventilation), exhaust function hand pump ball with rapid-action connector, 10 L dip tube, 25 L dip tube



## Pressurizing with inert gas

- Tested high performance materials to avoid any contamination caused by the system components
- All materials made of stainless steel and special sealing material with no organic compounds detectable
- Safe, easy and convenient solvent handling
- No risk of contamination from incoming air
- Cost effective solution due to economic concept of returnable container handling
- Permits construction of a central supply system
- Flexible product feed



Two different **connectors** for avoiding mismatch of gas and product

### Stainless steel clamp

to attach nozzle directly and drip-free to the drum [9.67106.0001]

**Safety hook** to avoid unintended solvent supply (push safety hook first to unblock the supply handle)

**Filling nozzle** with stainless steel coated PTFE tube [9.67100.9090]

**Integrated swivel joint** to avoid tube tensions

**Self-closing tear-off connectors** for quick connection and disconnection

**Spiral gas feeding tube** [9.67100.9051]

### Necessary complete products | pages 60 - 61

Dip tube for 10 L stainless steel drums [9.67100.1010]



Dip tube for 25 L stainless steel drums [9.67100.1025]



Dip tube for 190 L stainless steel drums [9.67100.1190]



### Accessories | pages 48 - 51

Opening key (2" / 3/4") [1.08803.0001]



Antistatic set (3 cables) [1.07070.0001]



Reducing valve, 0.2 bar [9.67100.9100]



Pressure safety device, 0.5 bar [9.67100.9004]



Stainless steel clamp for filling nozzle, wall attachment [9.67107.0001]



Stainless steel clamp for filling nozzle attachment to drums [9.67106.0001]



### System at a glance

<b>Order number</b>	<b>1.06710.0001</b>
<b>Suitability</b>	10 L, 25 L and 190 L stainless steel drums 10 L, 30 L and 185 L stainless steel barrels
<b>Operation mode</b>	Pressurizing with inert gas (house gas / gas bottle)

**Set components** Filling nozzle with stainless steel coated, flexible PTFE tube, 80 cm [9.67100.9090], Gas feeding tube [9.67100.9051], threaded adapter with vertical connections [9.67100.9002]. Please complete the set by adding the appropriate dip tube for your solvents container.

### Spare parts [as shown in the picture]

Filling nozzle with stainless steel coated, flexible PTFE tube (80 cm) [9.67100.9090]

Gas feeding tube [9.67100.9051]

Threaded adapter with horizontal connections [9.67100.9003]

Threaded adapter with vertical connections [9.67100.9002]

# Withdrawal systems and direct connections for stainless steel returnable drums



## Manual pressure build-up for high volumes by foot pump ball

- Safe, easy and convenient solvent handling
- Tested high performance materials to avoid any contamination caused by the system components
- High flexibility due to independence on gas supply



### Accessories

| pages 48-49

Opening key (2" / 3/4")  
[1.08803.0001]



Antistatic set (3 cables)  
[1.07070.0001]



### System at a glance

<b>Order number</b>	<b>1.19171.0001</b>
<b>Suitability</b>	180 L / 190 L / 200 L metal, stainless steel and composite drums (steel/PE)
<b>Operation mode</b>	Manual pressure build-up by foot pump ball
<b>Set components</b>	Withdrawal system body with 2" thread, foot pump ball with flexible tube and rapid-action connector, adjustable dip tube



## Direct connections to various instruments or product lines

### Stainless steel drum with direct instrument connection

**Customer's tubing**  
e.g. lines to instruments

#### Options to choose / alternatives

(Please choose either a tube or a nipple to connect existing lines.)

#### Stainless steel coated PTFE tube, 80 cm with nipple and (options)

- quick connector Rectus Type 21, female [9.67100.9058]
- threaded connector G3/8 (inner thread) [9.67100.9052]
- pipe connector for 10 mm tubes [9.67100.9057]

#### Nipple with tube connector, without tube (options)

- for flexible hoses of 3 x 1.5 mm [9.67100.1076]
- for flexible hoses of 6 x 4 mm [9.67100.1064]
- for flexible hoses of 8 x 6 mm [9.67100.1061]

#### Dip tube (options)

- 10 L stainless steel drum [9.67100.1010]
- 25 L stainless steel drum [9.67100.1025]
- 190 L stainless steel drum [9.67100.1190]

**Reducing valve** with integrated overpressure relief (IN / OUT: tube connector for hoses with 6 mm inner diameter) [9.67100.9100]

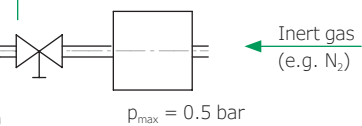

**Gas feeding tube**  
[9.67100.9051]

#### Threaded adapter (options)

- with vertical connectors [9.67100.9002]
- with horizontal connectors [9.67100.9003]

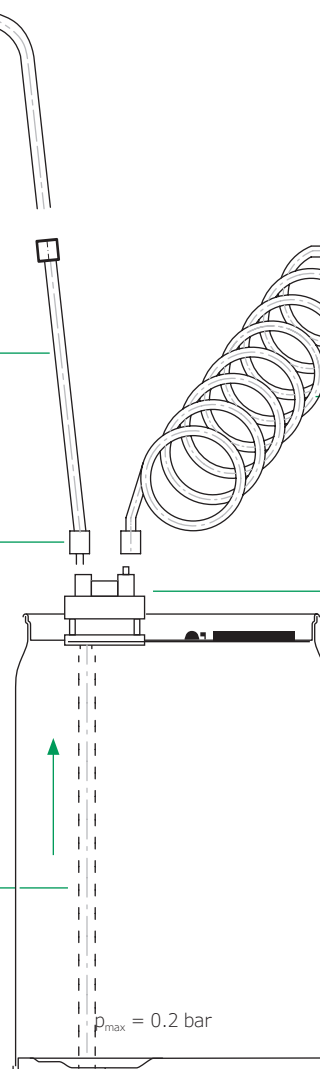
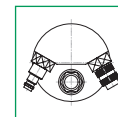

Direct connections to instruments or product lines are a safe option to increase process effectiveness. Customized installations are available on request with individual compilations of necessary products and technical drawings.

**Please contact your MilliporeSigma supplier to discuss your individual requirements.**

**Accessories | pages 48-51**

# One-way metal drums

[available from 10 L up to 180 L]



+ **Withdrawal system** for manual pressure build-up | pages 34-35









## Technical data

Parameter	10 L	25 L	25 L with PE	180 L	180 L with PE
Height	34 cm	52 cm	52 cm	88 cm	88.5 cm
Diameter	24.5 cm	29 cm	29 cm	59.5 cm	60 cm
Volume	13.5 L	28 L	28 L	216.5 L	203 L
Filling quantity	10 L	25 L	25 L	180 L	180 L
Weight (empty)	1.8 kg	3.6 kg	3.4 kg	21.3 kg	21.5 kg
Number per pallet	13	11	11	2	2
Openings [located]	2" [decentr.]	2" [centr.] and 3/4" [decentr.]	S56 x 4 (PP)	2" [centr.] and 3/4" [decentr.] (steel, galvanized)	2" with 3/4" (PP)
Material	steel	steel	steel with PE	steel	steel with PE



## Safety accessories for One-way Metal Drums | pages 48-49

Products	Ord. No.
<b>Safe handling</b>	
 Opening key (2" /3/4")	<b>1.08803.0001</b>
 Label set for self-labelling mixtures	<b>1.00801.0001</b>
 Antistatic set (3 cables)	<b>1.07070.0001</b>
<b>Withdrawal systems for solvents in drums</b>	
 Withdrawal system with manual pressure build-up	<b>1.01114.0001</b>
 Withdrawal system with manual pressure build-up (foot pump ball)	<b>1.19171.0001</b>
<b>Dip tubes for inert gas withdrawal system 1.06710.0001</b>	
 Dip tube for 25 L composite drums (steel/PE) for system 1.01114.0001	<b>9.67100.1026</b>



# Withdrawal systems for one-way metal drums

- Safe, easy and convenient solvent handling
- Tested high performance materials to avoid any contamination caused by the system components
- High flexibility due to independency on gas supply

## Manual pressure build-up by pump ball



### Accessories

| pages 48-49

Opening key (2" / 3/4")  
[1.08803.0001]



Antistatic set (3 cables)  
[1.07070.0001]



Dip tube for 25 L composite drum  
(steel/PE) [9.67100.1026]



### Spare parts

Dip tube for 10 L drums  
[9.67100.1012]



Dip tube for 25 L drums  
[9.67100.1028]



Hand pump ball  
[9.67114.0000]



### System at a glance

**Order number** 1.01114.0001

**Suitability** 10 L and 25 L metal, stainless steel and composite drums (steel/PE)

**Operation mode** Manual pressure build-up by pump ball

**Set components** Withdrawal system body with 2" clamp, hand pump ball with rapid-action connector, 10 L dip tube, 25 L dip tube. Please order the dip tube 9.67100.1026 for the usage with 25l composite drums (steel/PE).

## Manual pressure build-up for high volumes by foot pump ball



### Accessories

| pages 48-49

Opening key (2" / 3/4")  
[1.08803.0001]



Antistatic set (3 cables)  
[1.07070.0001]



Reducer (PE) from S56 x 4 to 2" thread (2" coarse to 2" fine thread)  
[9.67202.0000]



### System at a glance

**Order number** 1.19171.0001

**Suitability** 180 L / 190 L / 200 L metal, stainless steel and composite drums (steel/PE)

**Operation mode** Manual pressure build-up by foot pump ball

**Set components** Withdrawal system body with 2" thread, foot pump ball with flexible tube and rapid-action connector, adjustable dip tube

# Barrels – high quality return system

As the global market leader in laboratory reagents, we apply our demanding quality and safety standards not only to our reagents themselves, but also to the containers we supply them in. That's why we continuously develop and improve packaging and tailor-made solvent withdrawal systems that meet the requirements of our customers. Today we are able to provide a broad range of withdrawal systems and containers that is unrivaled by any other manufacturer.

Solvent management solutions from MilliporeSigma help to improve your materials management, to minimize the environmental impact of packaging waste and health risks for your employees, and to implement more cost-effective disposal processes.



## Your benefits

- Maximum user safety
- Easy and contamination-free solvent handling
- Application orientated solutions and individual installations
- Ecological and economical benefits



10 L



30 L



185 L



### Stainless steel barrels | pages 38-39

Stainless steel, due to its properties (e.g. its inertness), is an ideal packaging material, particularly with regard to the maintenance of the quality of solvents. MilliporeSigma has thus been using stainless steel barrels for various types of highly purified solvents for many years. The range of stainless steel barrels currently comprises 10 liter, 30 liter and 185 liter volumes.

- Optimum material characteristics (avoidance of interactions between solvents and packaging material)
- Use as returnable barrels
- Can be combined with a variety of withdrawal systems and level sensors
- Optimum emptying
- Stackable

### Withdrawal systems

Take advantage of perfectly matched systems for maximum safety in your individual application.

- ▶ Manual withdrawal system | page 40
- ▶ Withdrawal system with inert gas pressurizing | page 41
- ▶ Direct instrument connections | pages 42-43

### Cabinet storage and other varieties | pages 42-45

Direct connections to instruments or product lines serve as safe option to increase process effectiveness.

Customized installations are available on request with individual compilations of necessary products and technical drawings. Please contact your MilliporeSigma supplier to discuss your individual requirements.



10 L



30 L

### Fully sealed stainless steel barrels | page 33

For maximum dryness, we provide our dried solvents in specially designed stainless steel barrels with integrated dip tube. By using the appropriate withdrawal system, it is possible to prevent the solvent from contamination with moisture from the atmosphere. These specially tailored systems safeguard solvent quality and keep your analyses safe and dependable.

### Withdrawal systems

Take advantage of perfectly matched systems for maximum safety in your individual application.

- ▶ Withdrawal system with inert gas pressurizing | page 41
- ▶ Direct connections | pages 42-43

# Stainless steel barrels

[available from 10 L up to 185 L]



- + **Withdrawal system** manual pressure build-up | page 38
- + **Withdrawal system** for pressurizing with inert gas | page 41
- + **Direct connection** to instruments | page 43
- + **Level sensors** | pages 50-51

**Safe and easy handling**  
due to two large handles  
(optimal position for  
grounding clamps)

**Standard openings**  
to ensure highest  
interoperability

**Specially formed rims** for best  
stackability

**Protective cap**  
with originality sealing

**Engraved UN code**  
includes important safety  
information and provides  
packaging certification

**High quality  
stainless steel**  
with extreme  
durability, inertness  
and shock resistance  
for highest safety and  
product quality

**Unique, clear and  
complete labeling** with  
product specifications  
and all relevant hazard  
declarations

RETURNABLE  
PACKAGING

**Cost  
effectiveness and  
environmental  
protection** by using  
the barrel returning  
process



**Bottom reservoir**  
for optimal emptying



## Technical data







Parameter	10 L barrel	30 L barrel	185 L barrel
Height	31 cm	44 cm	97 cm
Diameter	28 cm	37 cm	58 cm
Wall thickness	1.5 mm	1.5 mm	1.5 mm
Volume	12 L	33.5 L	206 L
Filling quantity	10 L	30 L	185 L
Weight (empty)	5.5 kg	9.6 kg	31 kg
Number per pallet	11	6	2
Openings	2" centrally and 3/4" decentrally located		
Material	stainless steel 1.4301		







## Safety accessories for Stainless Steel Barrels | pages 48 - 49

Products	Ord. No.
----------	----------

## Safe handling



	Opening key (2" /3/4")	<b>1.08803.0001</b>
	Label set for labelling own containers acc. to GHS, DIN EN ISO, GLP	<b>1.00801.0001</b>
	Antistatic set (3 cables)	<b>1.07070.0001</b>
	Stainless steel clamp for filling nozzle, wall attachment	<b>9.67107.0001</b>
	Stainless steel clamp for filling nozzle, attachment to drums	<b>9.67106.0001</b>
	Reducing valve, 0.2 bar with integrated overpressure relief	<b>9.67100.9100</b>
	Pressure safety device, 0.5 bar	<b>9.67100.9004</b>

## Withdrawal systems for solvents in drums



	Withdrawal system with manual pressure build-up	<b>1.01123.0001</b>
	Withdrawal system for inert gas pressurizing	<b>1.06710.0001</b> (additional dip tube necessary)
	Dip tube for 10 l stainless steel barrels (for 1.06710.0001)	<b>9.67100.1040</b>
	Dip tube for 30 l stainless steel barrels (for 1.06710.0001)	<b>9.67100.1041</b>
	Dip tube for 185 l stainless steel barrels (for 1.06710.0001)	<b>9.67100.1185</b>

Products	Ord. No.
----------	----------

## Direct instrument connections

	HPLC bottle adapter S40 (supply) with valve and filter for direct bottle connection to HPLC tubes	<b>1.03830.0001</b>
	Reducer (stainless steel) from 2" to S40 thread	<b>1.01111.0001</b>

## Level sensors with continuous level detection

	Level sensor for 10 l stainless steel barrels	<b>1.67710.0001</b>
	Level sensor for 30 l stainless steel barrels	<b>1.67730.0001</b>
	Level sensor for 185 l stainless steel barrels	<b>1.67785.0001</b>



## Fully sealed stainless steel barrels

**Material:** Stainless steel

**Available packaging size:** 10 L and 30 L barrels

**Dimensions and net weight (barrel size):**

31 cm, ø 28 cm, 5.5 kg (10 L)

44 cm, ø 37 cm, 9.6 kg (30 L)

**Safety:** Fully sealed system

**Specifics:** Maximum protection against water contamination of dried solvents



# Withdrawal systems for stainless steel returnable barrels



## Manual pressure build-up

- Safe, easy and convenient solvent handling
- Tested high performance materials to avoid any contamination caused by the system components
- High flexibility due to independence on gas supply



### Accessories | pages 48 – 49

Opening key (2" / 3/4")  
[1.08803.0001]



Antistatic set (3 cables)  
[1.07070.0001]



### Spare parts

Dip tube for 10 L barrels  
[9.67100.1011]



Dip tube for 30 L barrels  
[9.67100.1029]



Hand pump ball  
[9.67114.0000]



Hand pump ball with quick connector [9.67100.1079]



### System at a glance

**Order number** 1.01123.0001

**Suitability** 10 L and 30 L stainless steel barrels

**Operation mode** Manual pressure build-up by pump ball

**Set components** Withdrawal system body with 2" clamp, hand pump ball with rapid-action connector, 10 L dip tube, 30 L dip tube. Please complete the set by adding the appropriate dip tube for your solvents container.



## Pressurizing with inert gas

- Safe, easy and convenient solvent handling
- Tested high performance materials to avoid any contamination caused by the system components
- Cost effective solution due to economic concept of returnable container handling
- Construction of a central supply system, direct connection to instruments or individual installations as options



Two different **quick connectors** for avoiding mismatch of gas and product. Horizontal connections available to reduce system height to a minimum. [9.67100.9003]

**Self-locking tear-off connectors** for quick connection and disconnection

**Safety hook** to avoid unintended solvent supply (push safety hook first to unblock the supply handle)

**Spiral gas feeding tube** [9.67100.9051]

**Filling nozzle with stainless steel coated PTFE tube** [9.67100.9090]

**Integrated swivel joint** to avoid tube tensions

### Necessary complete products

Dip tube for 10 L barrels  
[9.67100.1040]



Dip tube for 30 L barrels  
[9.67100.1041]



Dip tube for 185 L barrels  
[9.67100.1185]



### Accessories | pages 48 – 49

Opening key (2" / ¾")  
[1.08803.0001]



Antistatic set (3 cables)  
[1.07070.0001]



Reducing valve, 0.2 bar  
[9.67100.9100]



Pressure safety device, 0.5 bar  
[9.67100.9004]



Stainless steel clamp for filling nozzle,  
wall attachment [9.67107.0001]



### Spare parts (as shown in picture)

Filling nozzle with stainless steel coated, flexible  
PTFE tube (80 cm) [9.67100.9090]

Gas feeding tube [9.67100.9051]

Threaded adapter with horizontal connections  
[9.67100.9003]

Threaded adapter with vertical connections  
[9.67100.9002]

### System at a glance

<b>Order number</b>	<b>1.06710.0001</b>
<b>Suitability</b>	10 L, 25 L and 190 L stainless steel drums 10 L, 30 L and 185 L stainless steel barrels
<b>Operation mode</b>	Pressurizing with inert gas (house gas / gas bottle)
<b>Set components</b>	Filling nozzle with stainless steel coated, flexible PTFE tube, 80 cm [9.67100.9090], gas feeding tube [9.67100.9051], threaded adapter with vertical connections [9.67100.9002]



# Cabinet storage and direct connections

## Safety cabinet storage

### Fixed withdrawal system with flexible filling nozzle

Using special installations our customers reach maximum safety standards in solvent handling. One important option is to store solvent barrels inside a safety cabinet. A customized installation with stainless steel tubing directly from the safety cabinet to the fume hood avoids having any open solvent barrel in the laboratory during solvent withdrawal. A filling nozzle placed easily accessible inside the fume hood can be safely operated, while the solvent barrel itself is stored inside the safety cabinet. No hazardous solvent vapors enter the laboratory, thus ensuring maximum safety for users and environment. **Please ask us for your individual installation.**

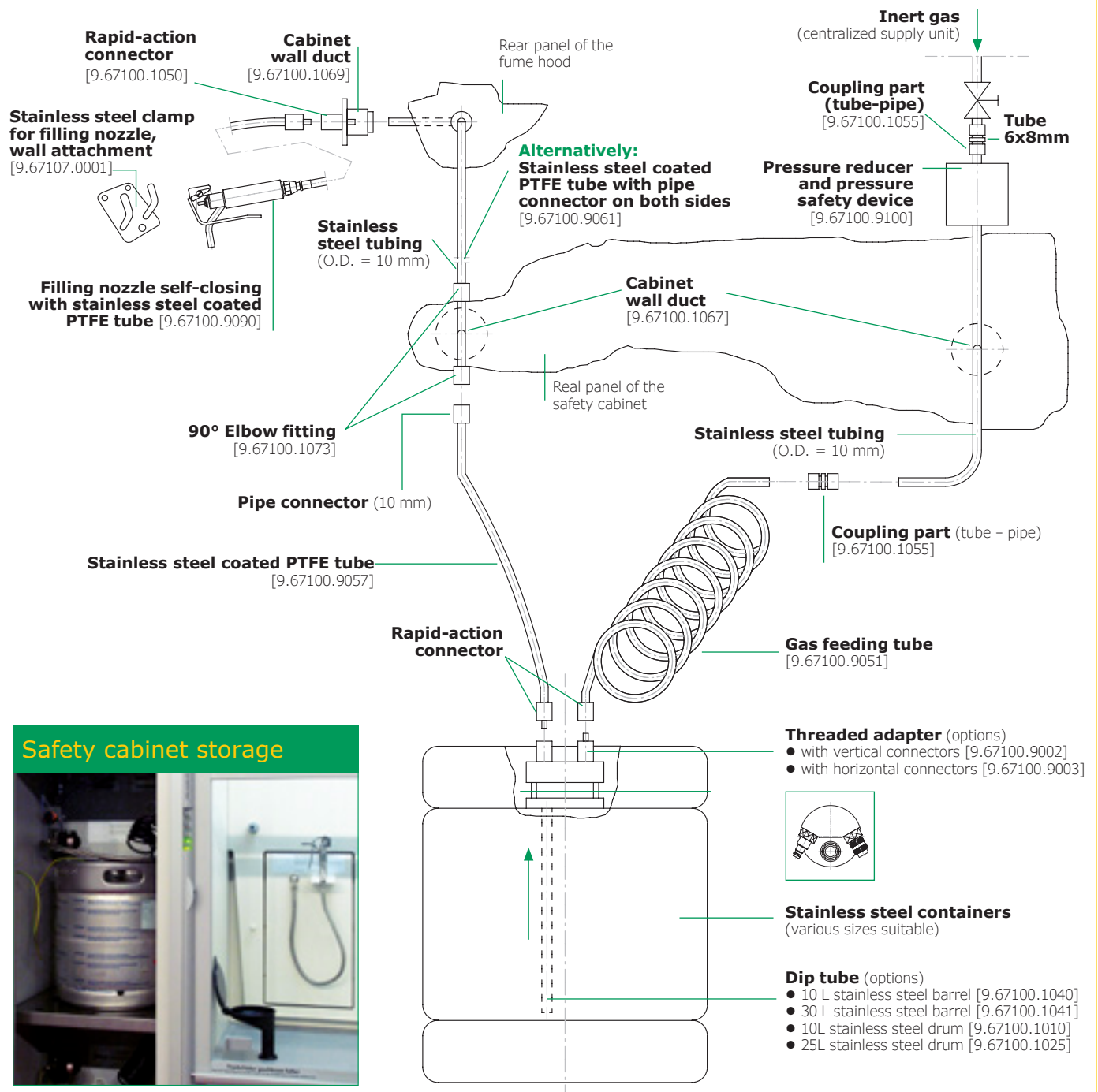

### Safety cabinet storage



# Direct connections to existing equipment

## HPLC adapter for direct instrument connection



Direct connections of barrels to instruments can be easily done by using an adapter with the HPLC bottle adapter.

### Benefits

- Maximum protection of users and environment by avoiding harmful emissions through integrated air vent / air filter
- Reliable analytical results and cost efficiency through contamination free solvent handling in a "closed system"
- Avoiding downtimes with firmly fixed capillaries, thus avoiding the air absorption
- Easy exchange of bottles due to free rotation (360°) of the HPLC adapter inlay

## Stainless steel barrel with direct instrument connection

**Customer's tubing**  
e.g. lines to instruments

### Options to choose / alternatives

(Please choose either a tube or a nipple to connect existing lines.)

#### Stainless steel coated PTFE tube, 80 cm with nipple and (options)

- quick connector Rectus Type 21, female [9.67100.9058]
- threaded connector G3/8 (inner thread) [9.67100.9052]
- pipe connector for 10 mm tubes [9.67100.9057]

#### Nipple with tube connector, without tube (options)

- for flexible hoses of 3 x 1.5 mm [9.67100.1076]
- for flexible hoses of 6 x 4 mm [9.67100.1064]
- for flexible hoses of 8 x 6 mm [9.67100.1061]

#### Dip tube (options)

- 10 L stainless steel barrel [9.67100.1040]
- 30 L stainless steel barrel [9.67100.1041]
- 185 L stainless steel barrel [9.67100.1185]
- 10 L stainless steel drum [9.67100.1010]
- 25 L stainless steel drum [9.67100.1025]
- 190 L stainless steel drum [9.67100.1190]

**Reducing valve** with integrated overpressure relief (IN / OUT: tube connector for hoses with 6 mm inner diameter) [9.67100.9100]

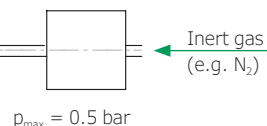

**Gas feeding tube** [9.67100.9051]

#### Threaded adapter (options)

- with vertical connectors [9.67100.9002]
- with horizontal connectors [9.67100.9003]

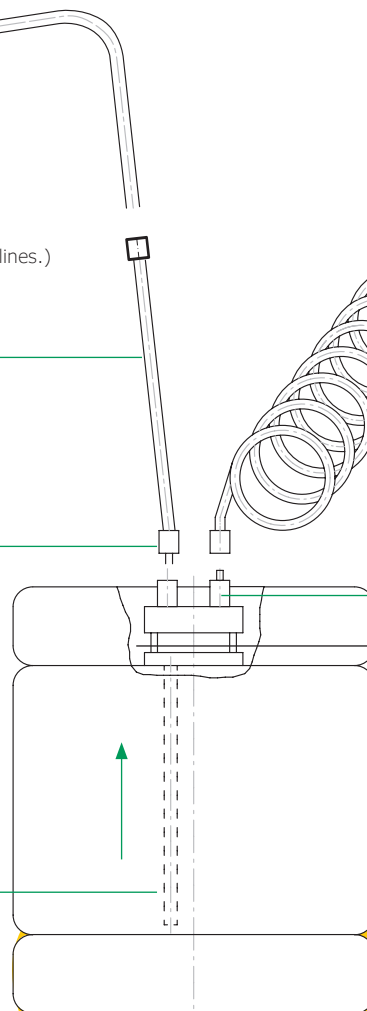
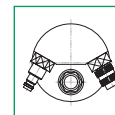

Another option is to connect solvent barrels directly from the safety cabinet to the HPLC instrument, thereby offering maximum user safety and environmental protection. Inert gas back-pressure can be applied to the barrel. Further process security can be provided by using the solvent level sensor technology. **These customized installations are available on request – please contact your MilliporeSigma supplier to discuss your individual requirements.**



## Central storage and supply

The various options in which individual components can be combined help you to optimize your work processes with regard to safety and efficiency. Where large volumes of solvents are turned around, delivery from a central safety cabinet or safety storage room to the point of use (e.g. laboratory fume hood) through a permanent supply circuit is one of the most rational ways of working.

**Please talk to your local MilliporeSigma supplier to find out your individual installation for your maximum safety.**

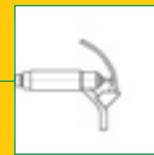

**Laboratory 1**

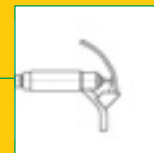

**Laboratory 2**

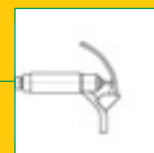

**Laboratory 3**

Central supply from one safety cabinet to several laboratories / fume hoods.





## Special varieties

MilliporeSigma's withdrawal systems cater to virtually any individual application. We provide an extensive range of withdrawal equipment and compatible accessories ranging from standard withdrawal systems for manual pressure build-up and systems that can be pressurized with inert gas, right up to customized solutions for individual installations. Especially for continuous solvent supply (e.g. 24/7 HPLC-run) a connection of several barrels in series could be a solution to reduce the complexity of your lab processes and save valuable time.

### Connection in series

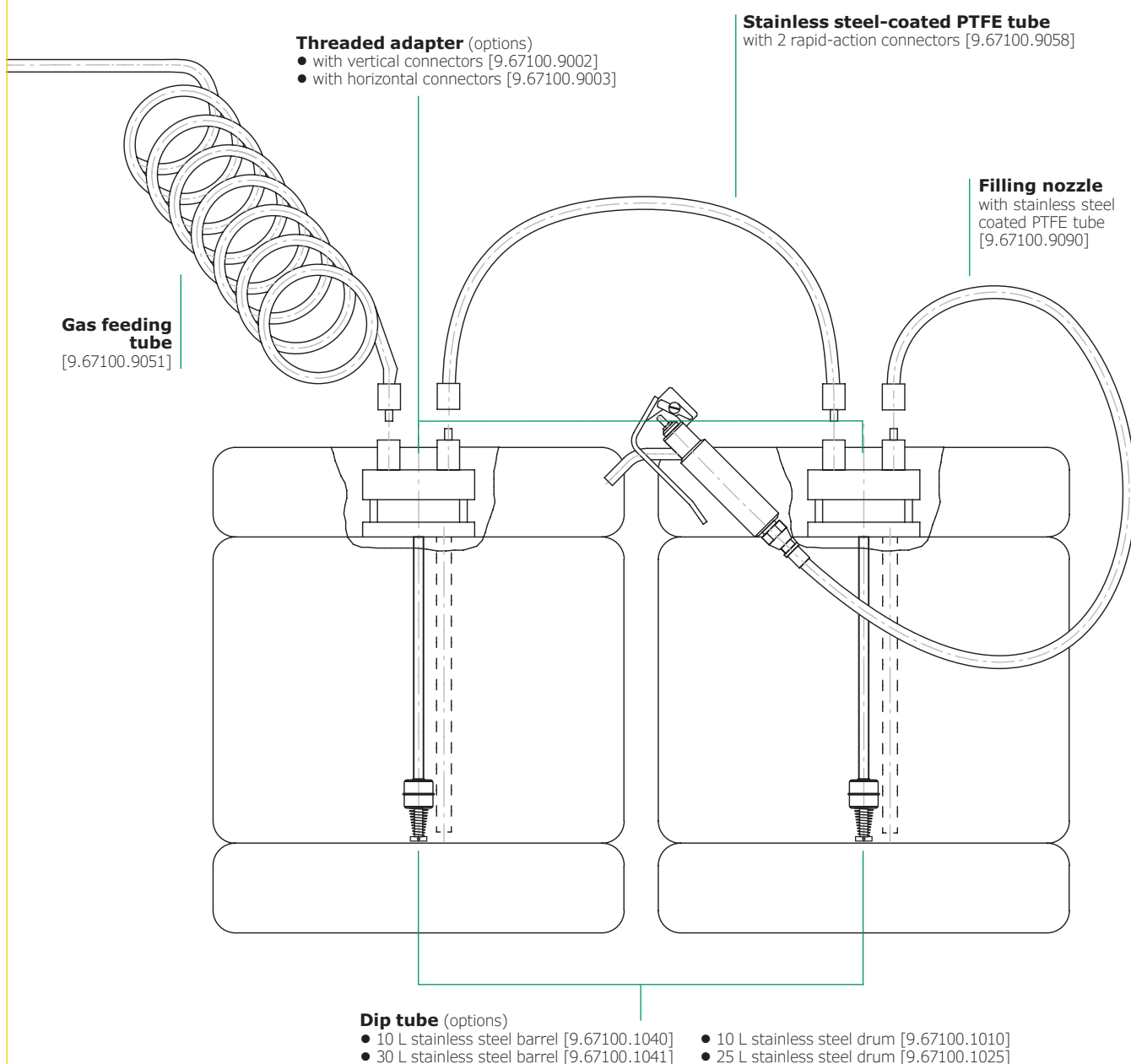

# Containers for high volumes

[available from 400 L up to 1400 L]



- + **Direct connection** to existing equipment
- + **Sampling** unit for product coupling



**Engraved UN code**  
includes important safety information and provides packaging certification

**Standard openings and connections**  
to ensure highest interoperability

**High quality stainless steel**  
with extreme durability, inertness and shock resistance for highest safety and product quality



**Cost effectiveness and environmental protection** by using the container returning process

**Retraction shoes**  
for safe transportation

**Bottom reservoir**  
for optimal emptying







## Technical data

<b>Material:</b>	Stainless steel
<b>Available packaging size:</b>	400 L, 1,000 L and 1,400 L, or customized



## Safety accessories for Containers | pages 48-51

Products	Ord. No.
<b>Safe handling</b>	
 Label set for self-labelling mixtures	<b>1.00801.0001</b>
 Antistatic set (3 cables)	<b>1.07070.0001</b>
<b>Withdrawal components and adapters</b>	
 Spiral gas feeding tube for coupling K	<b>9.67100.9051</b>
 Adapter for product connection (coupling M, SPM 08) to 1/2 NPT inner thread	<b>9.67100.1086</b>
Sampling unit for coupling M	<b>9.67400.0001</b>
Purging adapter for 9.67400.0001	<b>9.67400.0002</b>
Sampling unit for 1000 L container with Seliger coupling	<b>1.67400.0001</b>
Stainless steel coupling Seliger to G1" inner thread	<b>1.67402.0001</b>

Containers with volumes of 400 L and more are handled as customized packaging for standard and customized products.

Dedicated supply processes with rental agreements will be projected individually.

**Please contact your local MilliporeSigma supplier for further information and local availabilities.**

# Safety accessories for barrels & drums

## Drum key

for opening and closing MilliporeSigma barrels  
and drums with 2" and ¾" openings  
[1.08803.0001]

The specially designed drum key ensures safe and easy  
handling of the locking device of MilliporeSigma barrels  
and drums with 2" and ¾" opening.



## Antistatic device

for grounding metal containers when  
dispensing and filling flammable solvents  
[1.07070.0001]

If flammable liquids (e.g. solvents) are to be  
withdrawn or filled, the container must be properly  
grounded according to valid safety regulations to  
avoid explosions and fire risks. The relevant  
measures are to be taken to discharge static  
electricity. The antistatic device set allows quick  
and safe grounding of all components. It contains  
three cables for highest flexibility in grounding  
containers during all work steps. It comes in a  
suitcase for safe and professional storage of cables  
that are currently not in use. Cable length: 2 m

## Reducing valve

with integrated excess pressure safety device [9.67100.9100]

The pressure reducer with included overpressure relief is one of the safest combined solutions for reducing inert gas house lines to a working pressure of 0.2 bar. The integrated overpressure relieve avoids pressures higher than 0.5 bar inside the barrel according the Pressure Equipment Directive. The pressure reducer is equipped with a ball valve and with two tube connectors 8 x 6 mm.



## Pressure safety device 0.5 bar

[9.67100.9004]

The pressure safety device is used between the inert gas supply pressure bottle and the MilliporeSigma barrel / drum to avoid pressures higher than 0.5 bar inside the barrel / drum according the Pressure Equipment Directive. It is equipped with two tube connections of 6 x 8 mm.

## Safety wall ducts for safety cabinets and fume hoods

[9.67100.1067] and [9.67100.1069]

Individual solvent supply installations often include safety cabinets and fume hoods. The cabinet wall duct can be used as the link between the inner and outer side of safety cabinets with a maximum wall thickness of 55 mm. Connection ends are 10 mm tube ends. The hood wall duct can be used as link between the inner and outer side of the fume hood. It provides a 10 mm tube end on the outside and a G3/8 inner thread on the inner side.



## Stainless steel clamp

for filling nozzle attachment to drums [9.67106.0001] or to walls [9.67107.0001]

Safety and convenient handling are the basis for an important part of very special MilliporeSigma product developments. When using a pressurizing withdrawal system for stainless steel drums the MilliporeSigma filling nozzle (9.67100.1090 / 9.67100.9090) can be placed safely even directly on the small rim of the drum by using our screw clamp. For individual solvent withdrawal installations that end with a flexible filling nozzle inside a fume hood, a clamp for wall fastening is now available.





# Level sensors for process automation

## Level sensors for bottles

**Alarm display**  
[9.67100.2004]

**Instrument**

**Alarm display**  
[9.67100.2004]

**Instrument**

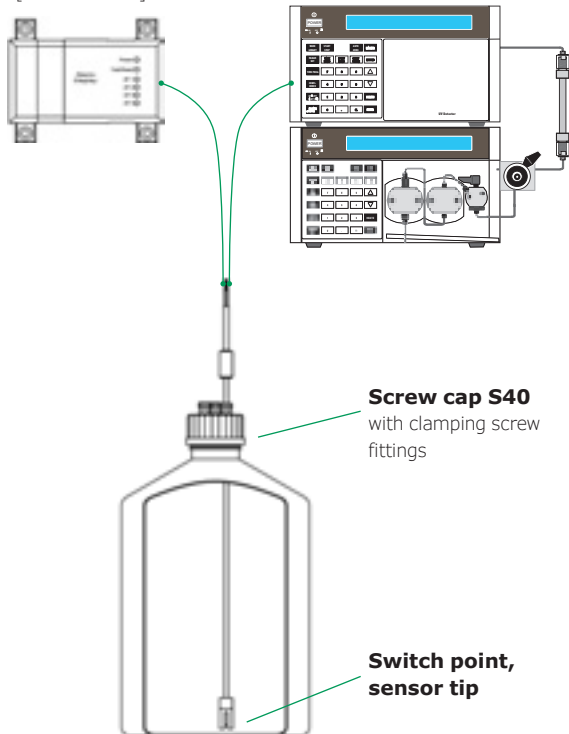

**Screw cap S40**  
with clamping screw fittings

**Switch point, sensor tip**

**Bottle level sensor for solvent supply**  
[9.67100.2001]

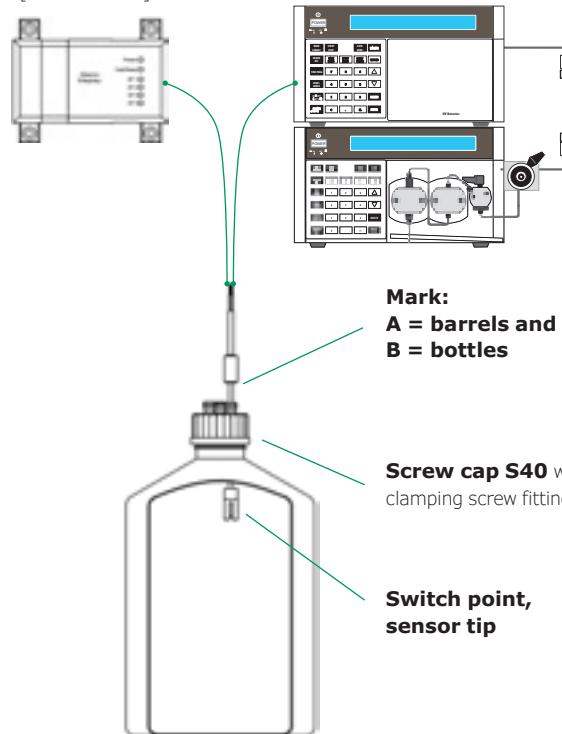

**Mark:**  
**A = barrels and drums**  
**B = bottles**

**Screw cap S40** with clamping screw fittings

**Switch point, sensor tip**

**Bottle level sensor for solvent disposal**  
[9.67100.2002]

As the pioneer in lab scale level sensing MilliporeSigma provides now a safe and convenient solution for process automation in laboratories. Primary for aluminum bottles but also for all other MilliporeSigma solvent bottles with S40 thread the sensor is pre-assembled in a screw cap with three connection positions to connect e.g. HPLC tubes of 3 mm directly to the bottle. The S40 screw cap is screwed onto the top of the bottle. With a clamping screw the sensor can be adjusted to several bottle sizes or also to the desired level.

- **Connecting the sensor to an alarm display for optical and acoustic signalling** purposes at the workplace with a built-in acknowledgement function.
- **Connecting the bottle sensor signal directly to an HPLC instrument** allows automatical stopping of the HPLC run to ensure a consistent supply of mobile phase, thus avoiding any reconditioning of the column. For solvent disposal the sensor prevents from overfilling and from the occurrence of harmful situations.



Level sensors for barrels and drums

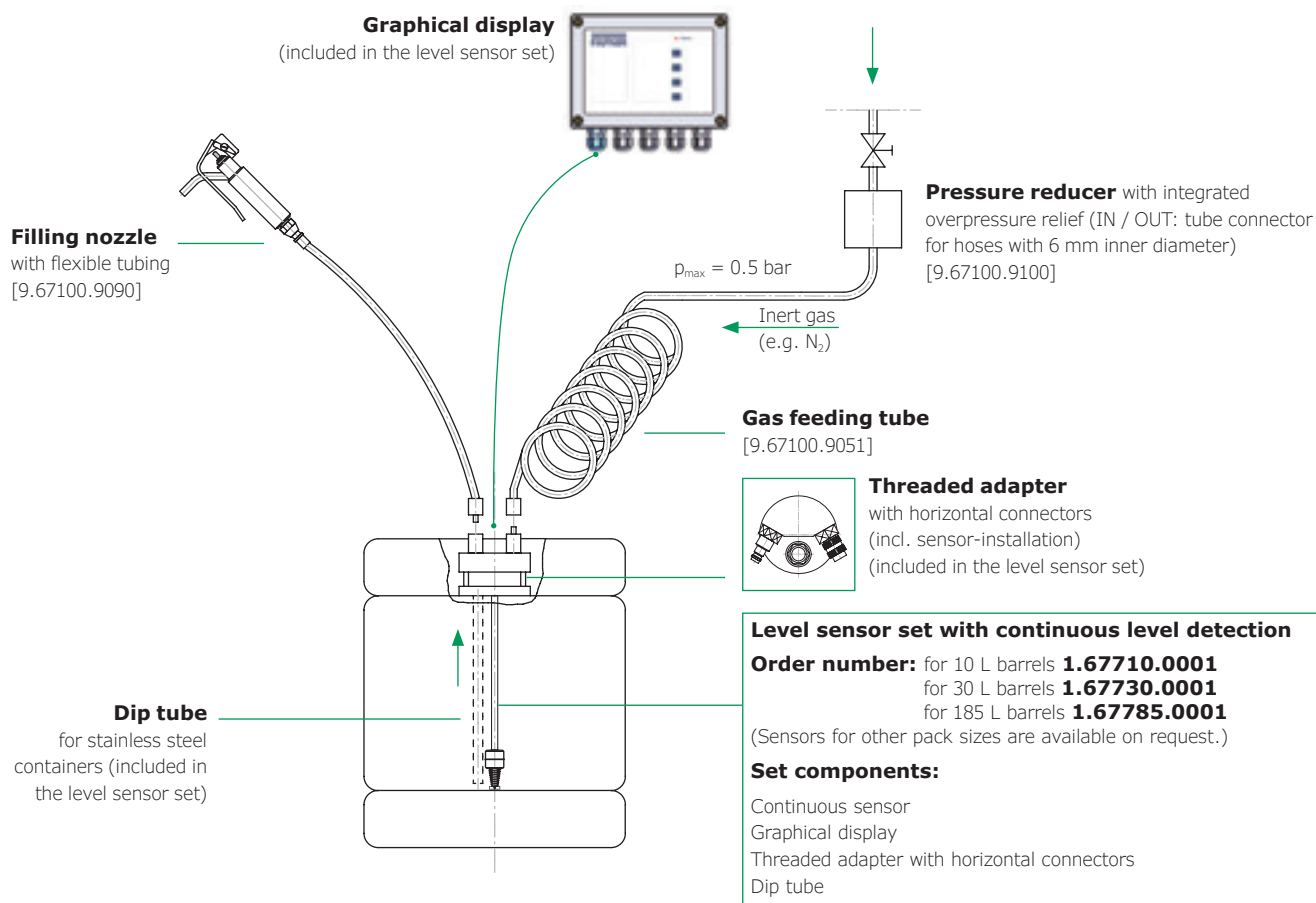

**Maximum safety and reliability for your daily work**

Continuous level sensor technology with ATEX approval provides maximum safety and reliability for your daily work. The graphical display always shows the exact solvent level inside the container. With adjustable alarm, individual management, measurement and control of solvent supply and disposal now are available and automatable, e.g. by visible control alarms or automatic control of HPLC instruments.

The new MilliporeSigma sensor facilitates the complex functionality of automated solvent handling: Pre-assembled for each pack size and convenient to install. By using the filling nozzle and the gas feeding tube the direct withdrawal can start immediately. For customized installations please contact your local supplier to get direct and individual support.







# Customized installations

[available for drums, barrels and containers]

Where large volumes of solvent are turned around, delivery from a central safety cabinet directly to the points of use (e.g. laboratory fume hood) through a permanent supply circuit is one of the most rational ways of working.

As the pioneer in developing high professional and innovative safety equipment for solvents (e.g. level sensors) we are always able to provide additional options for sustainable process automation and highest possible lab safety.

In a cooperative process we develop – together with you – the optimum solution for your individual application and environment.

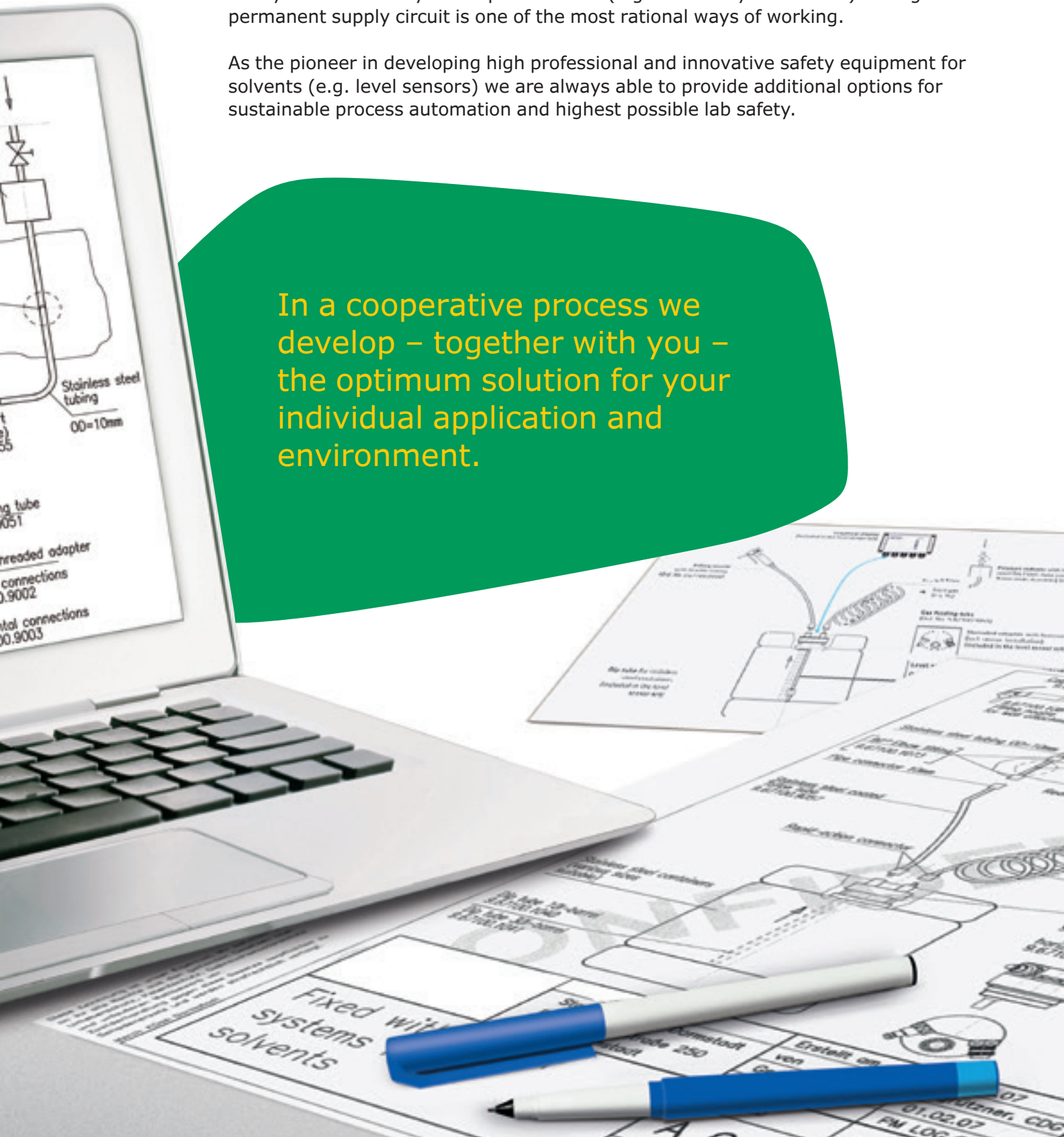



## For more information ...

[EMDMillipore.com/solvents-withdrawal](http://EMDMillipore.com/solvents-withdrawal)

Please do not hesitate to ask your local MilliporeSigma supplier for your individual installation.

Technical drawings of our various standard installations provide a first impression of the various installation options.

We also recommend alternative products for maximum flexibility, e.g. special product developments when space is limited in your lab.

An extensive MilliporeSigma product range of adapters and special connectors meets almost every individual installation requirement. If any product is not available directly from MilliporeSigma, we recommend suitable products from reputable suppliers so that you always will receive complete installation recommendations from us.





# Ordering information











## Safety accessories for bottles

Categories	Products	Ord. No.
Connection screw caps	 Adapter S40 for the direct aspiration of solvents through tubes of 3 mm O.D. from bottles with S40 thread (4 openings)	<b>1.09996.0001</b>
	 HPLC bottle adapter with 3 tube connections ID 3.2 mm, solvent supply by MilliporeSigma bottles	<b>1.03830.0001</b>
	 HPLC bottle adapter S40 with 3 tube connections and 1 connection for exhaust air filter, solvent disposal	<b>1.03831.0001</b>
	 Air valve for HPLC bottle adapter S40, supply (pack of 10)	<b>1.03832.0001</b>
	 Exhaust air filter for HPLC bottle adapter S40, disposal	<b>1.03833.0001</b>
	 Fittings for capillaries with 3.2 mm O.D., for HPLC bottle adapter S40 (pack of 10)	<b>1.03834.0001</b>
	 PTFE ferrule for capillaries with 3.2 mm O.D., for HPLC bottle adapter S40 (pack of 10)	<b>1.03835.0001</b>
	 Blanking plug for capillary connections with 3.2 mm O.D., for HPLC bottle adapter S40 (pack of 10)	<b>1.03836.0001</b>
Labels	 Label set according to GHS with 20 blank adhesive labels 80 x 110 mm, 168 adhesive hazard pictograms, 40 adhesive signal words, package insert with H- and P-statements	<b>1.00801.0001</b>
	 Adhesive Labels (pack of 100)	<b>1.08899.0001</b>
Level sensors	 Adapter with S40 thread and level sensor for emptying MilliporeSigma solvent bottles	<b>9.67100.2001</b>
	 Adapter with S40 thread and sensor for filling MilliporeSigma bottles	<b>9.67100.2002</b>
	 Display and alarm device for bottle level sensor	<b>9.67100.2004</b>
Opening tools	 Bottle key for opening and closing bottles with S40 and S28 screw caps	<b>1.08801.0001</b>
Safety carrier	 Safety carrier for MilliporeSigma 2.5 L glass bottles	<b>9.20078.0001</b>
	 Safety carrier for MilliporeSigma 4 L glass bottles	<b>1.40140.0001</b>

## Withdrawal systems for bottles













Categories	Products	Ord. No.
Withdrawal systems	 Withdrawal system for solvents with manual pressure build-up in MilliporeSigma bottles	<b>1.78178.0001</b>
Spare parts and optional products for withdrawal systems	 Conductive tubing for withdrawal system 1.78178.0001, length 40 cm (pack of 5)	<b>1.78179.0001</b>

## Safety accessories for barrels and drums

Categories	Products	Ord. No.
Essential safety equipment	 Antistatic device for earthing metal containers when dispensing and filling flammable solvents (set of 3 cables)	<b>1.07070.0001</b>
	 Pressure safety device 0.5 bar with 2 tube connections (6 x 8 mm)	<b>9.67100.9004</b>
	 Reducing valve 0.2 bar with 2 tube connections (6 x 8 mm and integrated excess pressure safety device 0.5 bar)	<b>9.67100.9100</b>
Filling nozzle clamps	 Stainless steel clamp for filling nozzles for drum attachment	<b>9.67106.0001</b>
	 Stainless steel clamp for filling nozzles for wall attachment	<b>9.67107.0001</b>
Labels	 Label set according to GHS with 20 blank adhesive labels 80 x 110 mm, 168 adhesive hazard pictograms, 40 adhesive signal words, package insert with H- and P-statements	<b>1.00801.0001</b>
	 Adhesive Labels (pack of 100)	<b>1.08899.0001</b>
Level sensors	 Continuous level sensor for solvents in 10 L stainless steel barrels	<b>1.67710.0001</b>
	 Continuous level sensor for solvents in 30 L stainless steel barrels	<b>1.67730.0001</b>
	 Continuous level sensor for solvents in 185 L stainless steel barrels	<b>1.67785.0001</b>
Opening tools	 Drum key for opening and closing containers with 2" and 3/4" screw caps	<b>1.08803.0001</b>

# Ordering information

## Withdrawal systems for barrels and drums

Categories	Products	Ord. No.
Withdrawal systems	 Withdrawal system for solvents with manual pressure build-up for 10 L and 30 L stainless steel barrels with 2" opening	<b>1.01123.0001</b>
	 Withdrawal system for solvents with manual pressure build-up for 10 L and 25 L stainless steel drums with 2" opening	<b>1.01114.0001</b>
	 Withdrawal system for solvents with manual pressure build-up for 200 L barrels and drums	<b>1.19171.0001</b>
	 Withdrawal system for stainless steel barrels and drums with threaded adapter and flexible lines for gas pressurizing (additionally necessary: dip tube suiting the particular type of container)	<b>1.06710.0001</b>
Spare parts and optional products for withdrawal systems	 Dip tube for 10 L stainless steel drums for withdrawal system Ord. No. 1.01114.0001	<b>9.67100.1012</b>
	 Dip tube for 25 L stainless steel drums for withdrawal system Ord. No. 1.01114.0001	<b>9.67100.1028</b>
	 Dip tube for 10 L stainless steel barrels for withdrawal system Ord. No. 1.01123.0001	<b>9.67100.1011</b>
	 Dip tube for 30 L stainless steel barrels for withdrawal system Ord. No. 1.01123.0001	<b>9.67100.1029</b>
	 Hand pump ball for withdrawal systems Ord. No. 1.01114.0001 and 1.01123.0001	<b>9.67114.0000</b>
	 Hand pump with rapid-action connector	<b>9.67100.1079</b>
	 Seal (O-Ring, 14 x 2.5 mm) for withdrawal systems Ord. No. 1.01114.0001 and 1.01123.0001	<b>9.67100.1048</b>
	 Seal (O-Ring, 56 x 3.6 mm) for withdrawal systems Ord. No. 1.01114.0001 and 1.01123.0001 and threaded adapter	<b>9.67100.1047</b>

## Accessories for high volume containers

Products	Ord. No.
 Stainless steel coupling AM 1/2 NF connection 1/2"	<b>9.67100.1086</b>
Sampling unit (stainless steel)	<b>9.67400.0001</b>
Blowing out adapter for sampling unit 9.67400.0001	<b>9.67400.0002</b>
Sampling unit for 1000l-container with Seliger-coupling	<b>1.67400.0001</b>
Stainless steel coupling Seliger to G1" inner thread	<b>1.67402.0001</b>













## Withdrawal components for individual installations

Categories	Products	Ord. No.
Adapters and reducers	Adapter (PE) K5 55 x 5 (inner thread) to S40 (outer thread) *	<b>1.67208.0001</b>
	Adapter (PE) KS 60 x 6 (inner thread) to S40 (outer thread) *	<b>9.67203.0000</b>
	Adapter (PTFE) GL45 (inner thread) to S40 (outer thread) *	<b>1.67216.0001</b>
	Bottle adapter (PTFE) S40 (bottle thread) to GL45 (outer thread) *	<b>1.67206.0001</b>
	Bottle adapter (PTFE) S40 (bottle thread) to S38 (outer thread)	<b>1.67207.0001</b>
	Coupling part between tube (6 x 8 mm) and pipe (O.D. 10 mm)	<b>9.67100.1055</b>
	Rapid-action connection nipple (gas side) with G3/8 thread	<b>9.67100.1051</b>
	Rapid-action connector for gas feed tube (8 x 6 mm) or for system venting	<b>9.67100.1052</b>
	Rapid-action connector for product tube 3 x 1.5 mm	<b>9.67100.1076</b>
	Rapid-action connector (product side) with G3/8 thread	<b>9.67100.1050</b>
	Rapid-action nipple for product tube 8 x 6 mm	<b>9.67100.1061</b>
	Rapid-action nipple with tube connection 6 x 4 mm	<b>9.67100.1064</b>
	Reducer (PE) from S40 to GL45	<b>9.67206.0001</b>
	Reducer (PE) from S56 x 4 to 2" thread (2" coarse to 2" fine thread)	<b>9.67202.0000</b>
	Reducer (stainless steel) from 2" to 3/4" thread	<b>9.67204.0000</b>
Reducer (stainless steel) from 2" to S40 thread	<b>1.01111.0001</b>	

\* Image similar







# Ordering information

## Withdrawal components for individual installations [continued]

Categories	Products	Ord. No.
Filling nozzles and taps	 Filling nozzle (stainless steel) self-closing, with stainless steel-coated PTFE tube (80 cm) with rapid-action connector	<b>9.67100.9090</b>
	 Filling nozzle (tap), self-closing, with G3/8 thread	<b>9.67100.1090</b>
	 Filling nozzle (tap), self-closing, with G3/8 thread for wall attachment	<b>9.67100.1084</b>
Dip tubes	 Dip tube for 10 L stainless steel drum for withdrawal system with 2" thread adapter	<b>9.67100.1010</b>
	 Dip tube for 25 L stainless steel drum for withdrawal system with 2" thread adapter	<b>9.67100.1025</b>
	 Dip tube for 190 L stainless steel drum for withdrawal system with 2" thread adapter	<b>9.67100.1190</b>
	 Dip tube for 10 L stainless steel barrel for withdrawal system with 2" thread adapter	<b>9.67100.1040</b>
	 Dip tube for 30 L stainless steel barrel for withdrawal system with 2" thread adapter	<b>9.67100.1041</b>
	 Dip tube for 185 L stainless steel barrel for withdrawal system with 2" thread adapter	<b>9.67100.1185</b>
	 Dip tube for 25 L combi container for withdrawal system Ord. No. 1.01114.0001	<b>9.67100.1026</b>
Thread adapters	 Threaded adapter 2" (stainless steel) with 2 vertical rapid-action connectors	<b>9.67100.9002</b>
	 Threaded adapter 2" (stainless steel) with 2 horizontal rapid-action connectors	<b>9.67100.9003</b>



## Withdrawal components for individual installations [continued]

Categories	Products	Ord. No.
Tubings	 Spiral gas feeding tube (Nylon) with rapid-action connector Rectus Type 21 (length: 180 cm, FFKM Sealing)	<b>9.67100.9051</b>
	 * Stainless steel-coated PTFE tube (80 cm) with rapid-action nipple and threaded connector G3/8	<b>9.67100.9052</b>
	 * Stainless steel-coated PTFE tube (80 cm) with 2 rapid-action connectors (1x coupling, 1x nipple)	<b>9.67100.9058</b>
	 * Stainless steel-coated PTFE tube (80 cm) with rapid-action coupling and pipe connector (O.D. 10 mm)	<b>9.67100.9062</b>
	 Stainless steel-coated PTFE tube (80 cm) with rapid-action connector and pipe connector (O.D. 10 mm)	<b>9.67100.9057</b>
	 * Stainless steel-coated PTFE tube (100 cm) with pipe connector (O.D. 10 mm) on both sides	<b>9.67100.9061</b>

\* Image similar



# Withdrawal system suitability



Ord. No.	Products	Stainless Steel Barrels			Stainless Steel Drums		
		10 L	30 L	185 L	10 L	25 L	190 L
1.06710.0001	Withdrawal system for stainless steel barrels and drums with threaded adapter and flexible lines, for gas pressure, necessary: dip tube suit the particular type of container dip tube additionally	+	+	+	+	+	+
		9.67100.1040	9.67100.1041	9.67100.1185	9.67100.1010	9.67100.1025	9.67100.1190
1.01123.0001	Withdrawal system for solvents with manual pressure build-up in barrels	+	+				
1.01114.0001	Withdrawal system for solvents with manual pressure build-up in drums dip tube information				+	+	
1.19171.0001	Withdrawal system for solvents with manual pressure build-up in 200l-barrels and drums			+			+

# Connections for barrels & drums

Ord. No.	Products
9.67100.1050	Rapid-action connector (product side) with 3/8" thread
9.67100.1052	Rapid-action connector for gas feed tube (8x6 mm) or for system venting
9.67100.1051	Rapid-action connecting nipple (gas side) with 3/8" thread
9.67100.1061	Rapid-action connector for product tube (8 x 6 mm)
9.67100.1064	Rapid-action nipple with tube connection 6x4 mm
9.67100.1076	Rapid-action connector for product tube 3x1.5 mm
9.67100.1069	Hood wall duct with tube connector (OD 10 mm) for G 3/8 internal thread
9.67100.1055	Coupling part between tube (6x8 mm) and pipe (O.D. 10 mm)
9.67100.1073	Union elbow connector for metric tube to metric tube (o.d. 10 mm)
9.67100.1086	Stainless steel coupling AM 1/2 NF connection 1/2"
1.67402.0001	Stainless steel coupling Seliger to G1" inner thread
1.01111.0001	Reducer (stainless steel) from 2" to S40 thread
9.67204.0000	Reducer (stainless steel) from 2" to 3/4" thread



**Metal Drums**

10 L

25 L

25 L with PE-inliner  
(combi drum)

180/190 L

180/190 L with PE-inliner  
(combi drum)

+

+

+

shorten 10l-dip tube by 17 mm

shorten 25l-dip tube by 9 mm

use alternative dip tube  
**9.67100.1026**

+

female Type 21  
male type 21  
G 3/8 outer thread  
G 3/8 inner thread  
pipe connector 10 mm  
stainless steel pipe 10 mm  
tube connector for 3x1.5 mm  
tube connector for 6 x 4 mm  
tube connector for 8 x 6 mm  
1/2" NPT inner thread  
Seliger  
G1" inner thread  
G2" outer thread  
S40 outer thread  
G3/4" outer thread  
Coupling SPM08  
(1000l container)

	x		x														
	x								x								
		x	x														
		x							x								
		x					x										
				x		x											
					x				x								
					2x												
										x							x
										x	x						
												x	x				
												x		x			

# Tubings

Ord. No.	Products	female Type 21	male type 21	G 3/8 outer thread	G 3/8 inner thread	pipe connector 10 mm	tube length 80 cm	tube length 100 cm	filling nozzle
9.67100.9051	Spiral gas feeding tube (Nylon) with rapid-action connector, FFKM sealing, length 180 cm	x							
9.67100.9052	Stainless steel-coated PTFE-tube (80 cm) with rapid-action nipple and threaded connector G 3/8		x		x		x		
9.67100.9056	Stainless steel-coated PTFE-tube (80 cm) with 3/8" threaded connector and pipe connector (O.D. 10 mm)				x	x	x		
9.67100.9057	Stainless steel-coated PTFE-tube (80 cm) with rapid-action connector and pipe connector (O.D. 10 mm)		x			x	x		
9.67100.9058	Stainless steel-coated PTFE-tube (80 cm) with 2 rapid-action connectors (1x coupling, 1x nipple)	x	x				x		
9.67100.9061	Stainless steel-coated PTFE-tube (100 cm) with pipe connector (O.D. 10 mm) on both sides					2 x		x	
9.67100.9062	Stainless steel-coated PTFE-tube (80 cm) with rapid-action coupling and pipe connector (O.D. 10 mm)	x				x	x		
9.67100.9090	Filling nozzle (stainless steel) self-closing, with stainless steel-coated PTFE-tube and rapid action nipple		x						x

# Bottle connections

Ord. No.	Products	PE	PTFE	S40 outer thread	G2" coarse outer thread	G2" fine inner thread	GL45 outer thread	GL45 inner thread	S38 outer thread	KS55x5 inner thread	KS60x6 inner thread	S40 inner thread
9.67203.0000	Reducer (PE) from KS60x6 (inner thread) to S40 (outer thread)	x		x							x	
9.67202.0000	Reducer (PE) from S 56X4 to 2" thread (2" coarse to 2" fine thread)	x			x	x						
9.67206.0001	Reducer (PE) from S40 To GL45	x					x					x
1.67206.0001	Bottle adapter (PTFE), S40 (bottle thread) to GL45 (outer thread)		x				x					x
1.67207.0001	Reducer (PTFE) from S40 to S38		x						x			x
1.67208.0001	Adapter KS55x5 (inner thread) to S40 (outer thread)	x		x						x		
1.67216.0001	Bottle adapter GL45 (inner thread) to S40 (outer thread)		x	x			x					
9.67207.0001	Reducer (PE) from S40 to S38	x							x			x

**DISCLAIMER**

Our withdrawal systems and safety accessories have been developed and optimized for the use with containers and chemicals from Merck KGaA, Darmstadt, Germany. Merck KGaA, Darmstadt, Germany therefore disclaims any warranty or liability for the operability of its withdrawal systems and safety accessories in connection with containers or chemicals from other manufacturers.

Merck KGaA, Darmstadt, Germany reserves the right to refrain from the delivery of withdrawal systems and safety accessories if the respective order does not indicate that each withdrawal system and safety accessory will be used in combination with appropriate chemicals and containers from Merck KGaA, Darmstadt, Germany.

We inform and advise our customers to the best of our knowledge and ability but without any engagement or liability on our part. Our customers must obey all existing laws and regulations. This also applies in respect of any protected rights of third parties. Our information and advice does not eliminate the need for our customers to check, on their own responsibility, that our products are suitable and safe for the purpose envisaged.

# Supelco®

Analytical Products

MilliporeSigma  
400 Summit Drive  
Burlington, MA 01803

**EMDMillipore.com**

To place an order or receive technical assistance in the U.S. and Canada, call toll-free **1-800-645-5476**

For other countries across Europe and the world, please visit: **[EMDMillipore.com/offices](https://www.emdmillipore.com/offices)**

For Technical Service, please visit: **[EMDMillipore.com/techservice](https://www.emdmillipore.com/techservice)**

© 2018 Merck KGaA, Darmstadt, Germany and/or its affiliates. All Rights Reserved. MilliporeSigma, the vibrant M, EMPARTA, EMPLURA, EMSURE, LiChrosolv, MagniSolv, Prepsolv, SeccoSept, SeccoSolv, SupraSolv, UniSolv and Uvasol are trademarks of Merck KGaA, Darmstadt, Germany or its affiliates. All other trademarks are the property of their respective owners. Detailed information on trademarks is available via publicly accessible resources.

Lit. No. MS\_BR2712EN  
2017 - 04976  
09/2018